

COVID-19
Safety and
Sanitization
Equipment

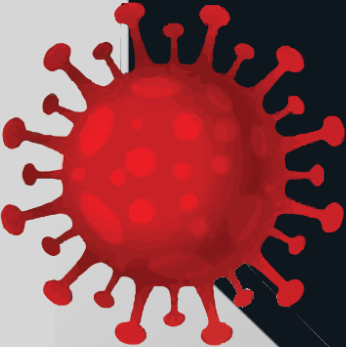
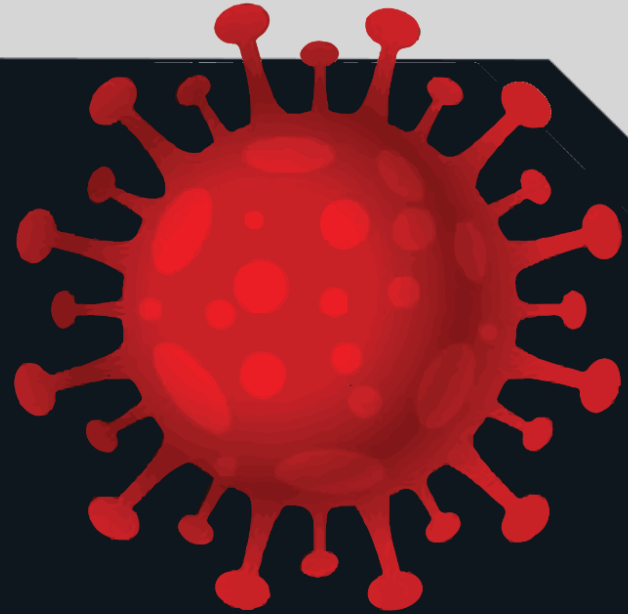
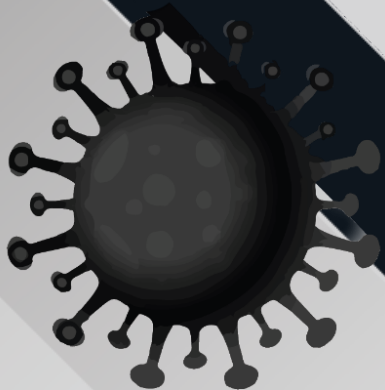

After the spread of the Corona,
it became a pandemic threatening the world.
With a gradual return to life, and to maintain your
safety and prevent this epidemic
We offer you several products for your safety and
permanent sterilization for any disease that harms
you.

SANITIZATION PASSAGE

AUTO SANITIZATION PASSAGE:

In response to the increasing risk of ongoing pandemic COVID-19 virus, we provide you with the Smart Sanitizing Gates (SSG) as a preventive measure and to stop the spread of the COVID-19 virus. This aims to disinfect a person 99.9% and gives a smart solution for protection. It also kills spores, fungi and other bad bacteria and is proven to be safe and non-toxic.

**Available starting from
00th June**



AUTO SANITIZATION PASSAGE:

- Well calculated consumption rate using high end pumps that control the pressure rate ensuring efficient sanitization liquid consumption & omit excesswastage.
- Strong drainage system that is made to withstand the wasted sanitization liquid & drain it immediately to ensure no water puddles forms that would flood the floor.

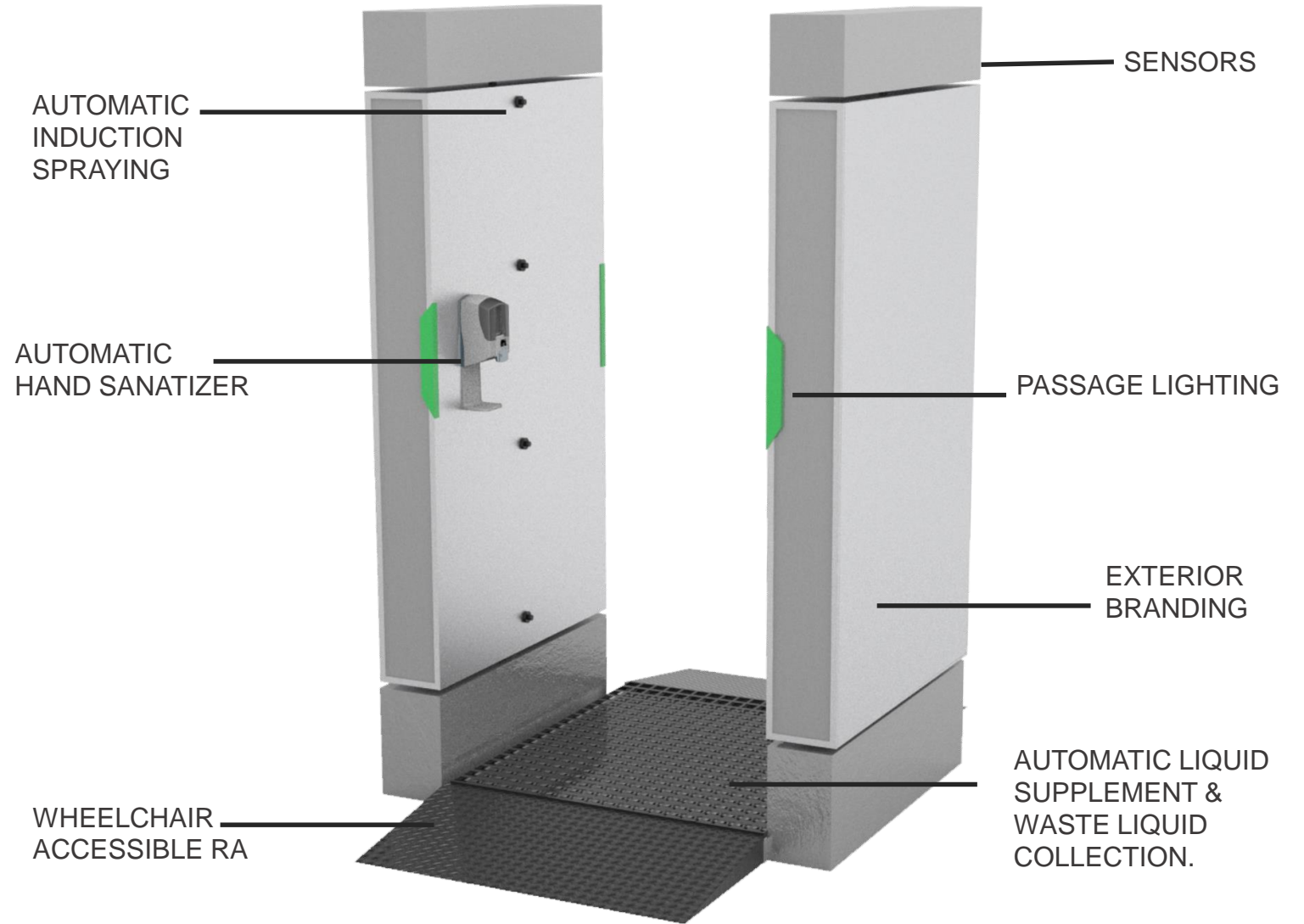

DUAL AUTO SANITIZATION PASSAGE:

Dual Sanitizing Gate are available Catering to the needs of large institutions with multiple & large entrances for a great number of people.

**Available starting from
00th June**





4

5

BRANDING & CUSTOMIZATION

The auto sanitization passages can be tailored to your brand, following your brand guidelines and meeting your requirements.



CUSTOMIZED UNITS

Our units are customizable with extra features:

- **Non- Contact Temperature Screening System**
- **Facial Recognition System**
- **Employee Sign In System**
- **Footfall Counter**

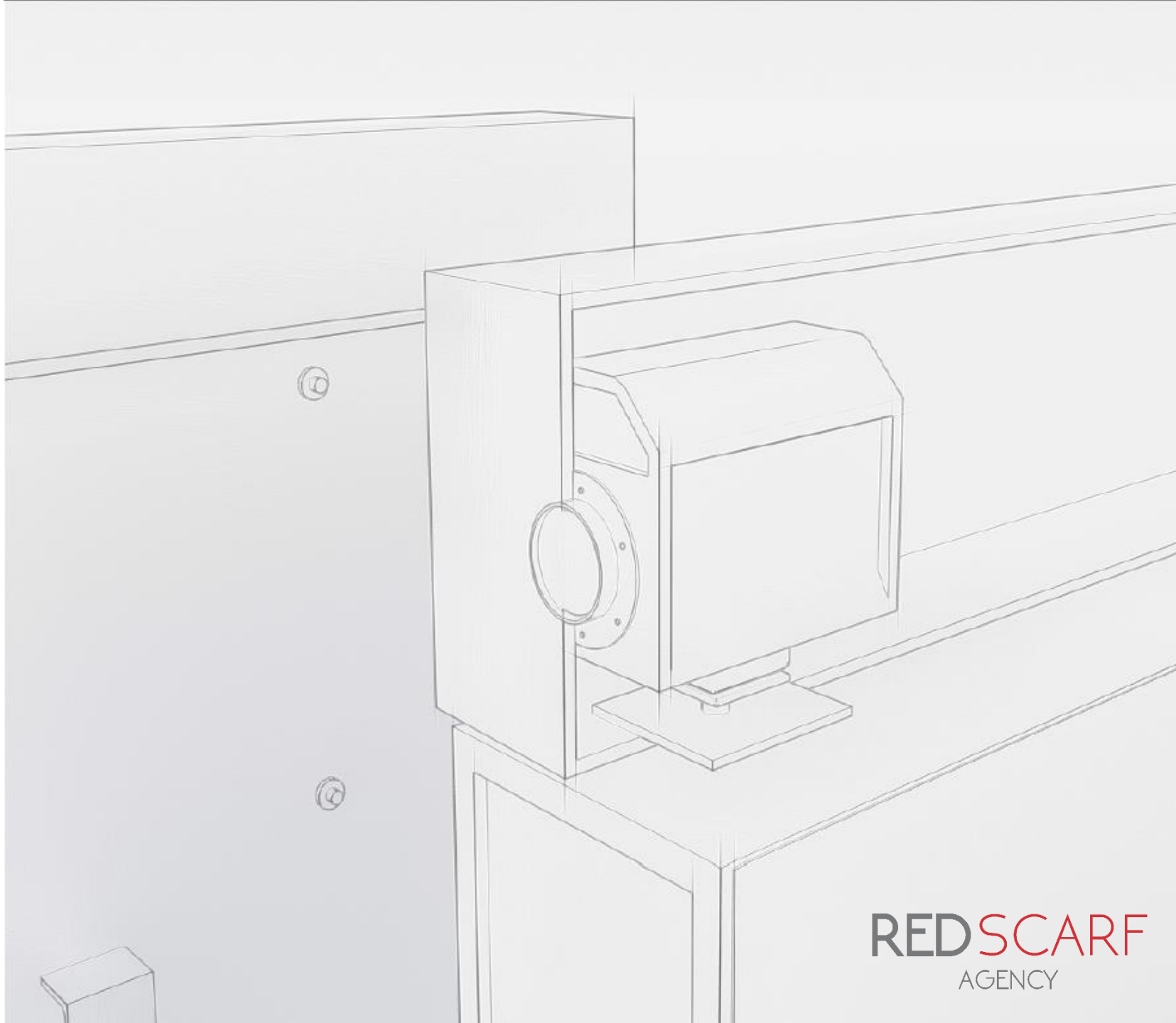

THERMAL MONITORING

THERMAL MONITORING

Frontline staff or security guards are at risk when performing multi-tasks such as manual temperature screening, manually record visitor information, visually monitor the crowd, monitor who to allow access during the day, and require to notify Business Continuity Manager (BCM) or management immediately when detecting suspects who violate rules.



No Safety Distance
Exposed to Virus

= 50



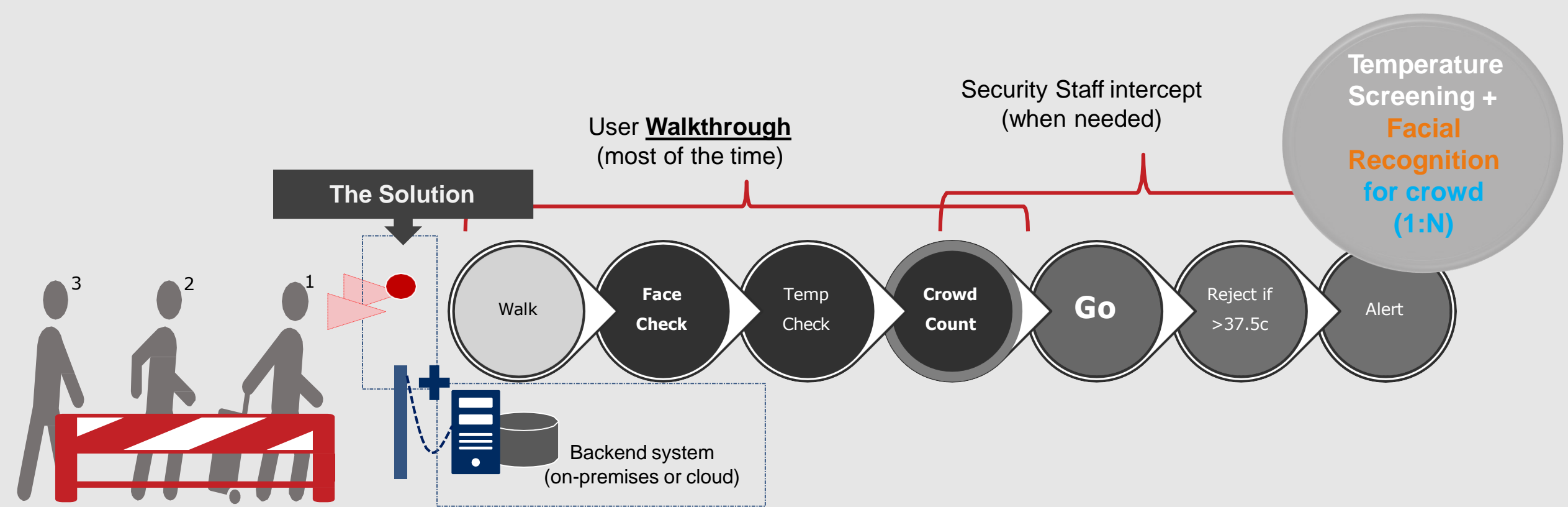

- This solution further expand our thermal solutions for a bigger & crowded area i.e. heavier processing
- To control those walk-in crowd, our solution will also do crowd counting so that security staff can intercept when the number cross certain threshold (i.e. reduce the need for manual people count)
- As this solution will be deployed in open area, the solution will only display face recognition info and crowd count to the security staff in charge for people identification & crowd control

- Capturing facial together with temperature.
Each face are captured with their temperature
- Recognizing if visitor vs employees
- Automated capturing
- Immediate alerting functionality
- Dashboard and reporting
- Easy maintenance and management
- Installation can be standalone in a area or installation can be done at the reception area
- Optionally to connect to NVR for recording



Example of a simple rollout

Simple Installation

- NEC Thermal FR Solution embedded Hardware
- Thermal Camera
- Customized Camera Stand with Mounting
- 27" LED FULL HD Monitor
- LAN Cable
- 5-port POE Network Switch
- HDMI Cable
- Monitor Floor Stand

Terms and Condition

- All in one (Plug and Play)
- 27" LED FULL HD MONITOR to be procured by Customer separately
- Just require power to power on the system. Customer to provide power extension cord.
- No need to connect to office network for it to work. No dependencies
- Optionally to connect to office network.

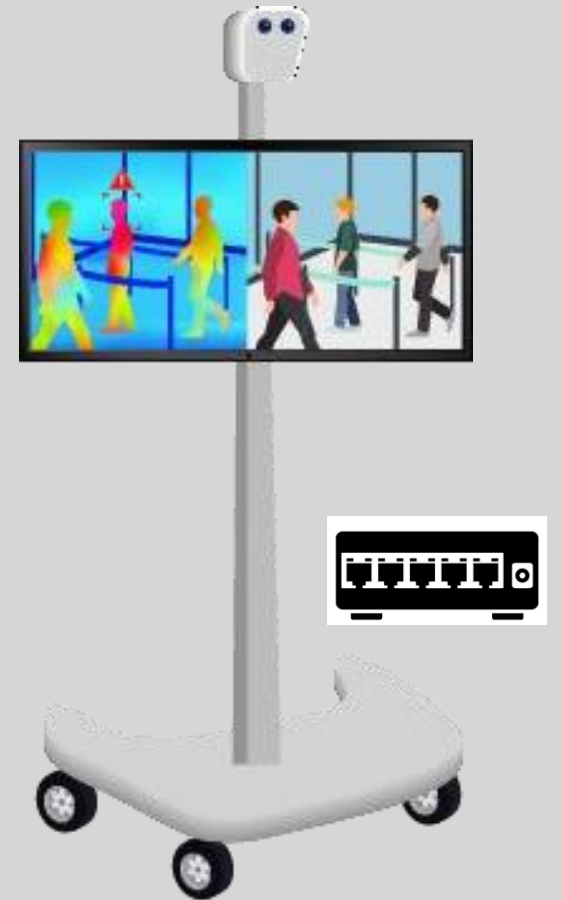

Centrally Manage

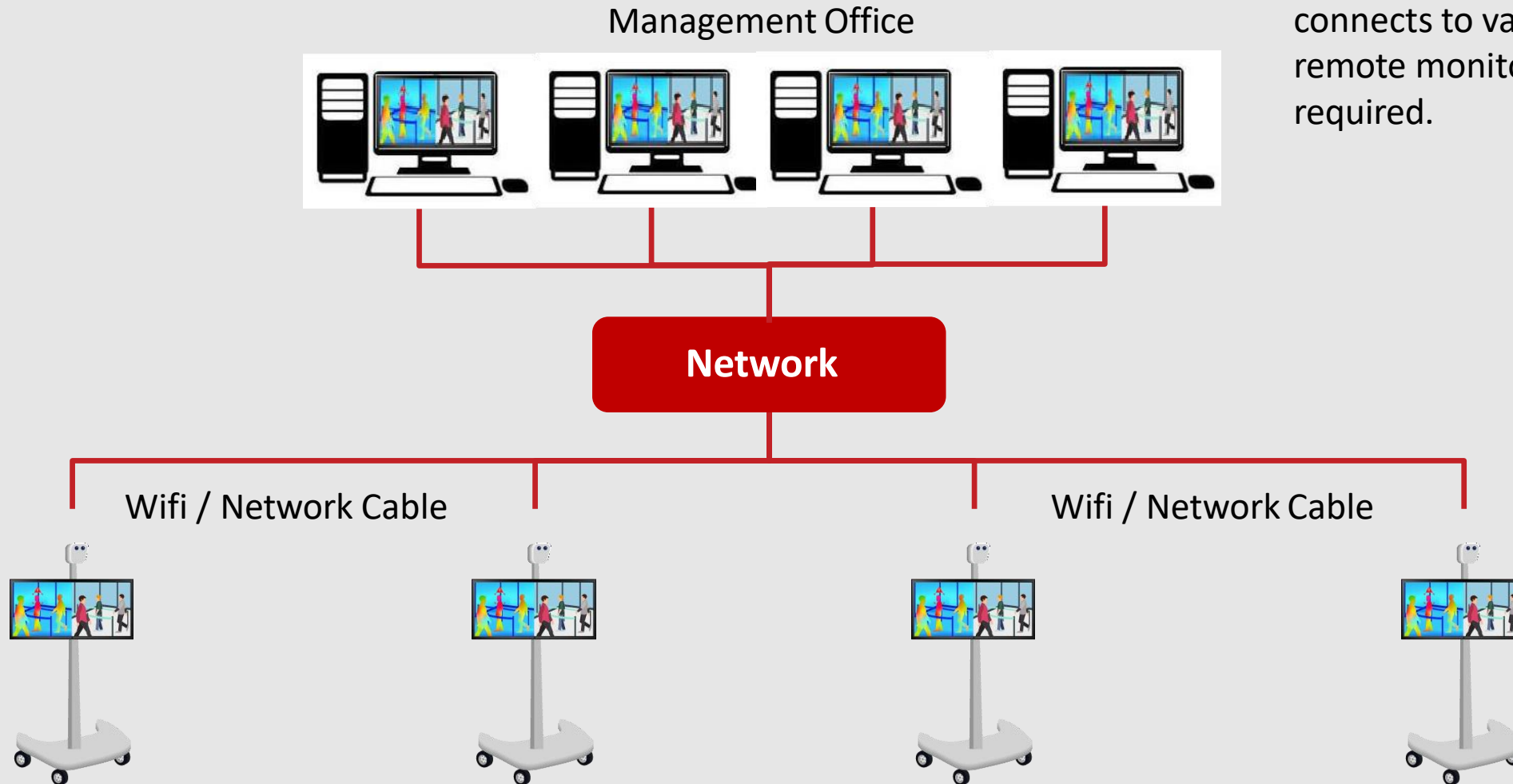

Management office can connect to various site for remote monitoring when required.

* Wifi module can be obtained optionally

Thank You
For Your Time

CONTACT US:

Mobile : +973 3631 8893

Office : +973 1740 5052

Email : Info@red-scarf.com

RED SCARF
AGENCY